

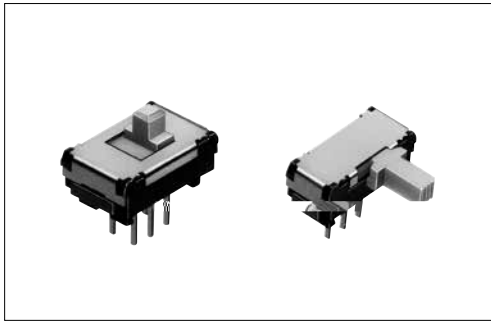

Ü s " 7



["		? i
Kv-ç Kl-ç ÈÉµ		" 7 % \$ N" 7 % \$
α(ÈÈ ù p a		N\$ NBY N\$ NBY
îTî		QPTJUJPO QPTJUJPO
		• / B D ' C • / C ' B D • /
Tp	íµ	DZDMFT
	µ	DZDMFT " 7 % \$

■ Á Ö B «

› ñ NN	T † Z _	T † È NN	È ^ "	α Ä "	½ ZE	MÐHK	o α ZE	Kl è † È QDT		Á Ö I	m								
								o ' g											
7FSUJDBM					4UBOEBS E	/PO TIPSUJOH				SSSS912000									
					4OBQ JO U					SSSS910400									
					4UBOEBS E	/PU TQFDJGJFE				SSSS919500									
					4OBQ JO U					SSSS918500									
					4UBOEBS E	/PO TIPSUJOH				SSSS922000									
					4OBQ JO U					SSSS921800									
					4UBOEBS E	/PU TQFDJGJFE				SSSS912500									
					4OBQ JO U					SSSS910800									
					4UBOEBS E	/PO TIPSUJOH				SSSS919800									
					4OBQ JO U					SSSS918700									
					4UBOEBS E	/PU TQFDJGJFE				SSSS922500									
					4OBQ JO U					SSSS923200									
					4UBOEBS E	/PO TIPSUJOH				SSSS920600									
					4OBQ JO U					SSSS916900									
)PSJ[POUBM								4UBOEBS E	/PO TIPSUJOH				SSSS915001	
													4OBQ JO U					SSSS91B900	
4UBOEBS E	/PU TQFDJGJFE	SSSS91B900																	
4OBQ JO U		SSSS926400																	
4UBOEBS E	/PO TIPSUJOH	SSSS928500																	
4OBQ JO U		SSSS916400																	
4UBOEBS E	/PU TQFDJGJFE	SSSS914503																	
4OBQ JO U		SSSS91B600																	
4UBOEBS E	/PO TIPSUJOH	SSSS91A601																	
4OBQ JO U		SSSS925800																	
4UBOEBS E	/PU TQFDJGJFE	SSSS923802																	
4OBQ JO U		SSSS928200																	
4UBOEBS E	/PO TIPSUJOH	SSSS925701																	
4OBQ JO U																			

■ ? i
Ü

Ä Ö	" Q D T		g Q j N N
	Q ° '	Q g	
SSSS921800, SSSS923200, SSSS920600, SSSS928500, SSSS928200, SSSS925701			
SSSS912000, SSSS910800, SSSS926400, SSSS910400, SSSS919800, SSSS916400, SSSS919500, SSSS918700, SSSS914503, SSSS918500, SSSS922500, SSSS91B600, SSSS922000, SSSS916900, SSSS91A601, SSSS912500, SSSS915001, SSSS925800, SSSS91B900, SSSS923802			€ €

■ " T M m
T † ~

6 O J U N N

/ P	T M	† — È ^ ð ½ d j m 1 " Z _ A
1-pole, 2-position Standard type		
1-pole, 2-position Snap-in type		
1-pole, 3-position Standard type		

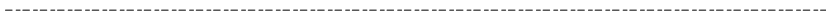
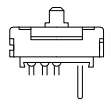

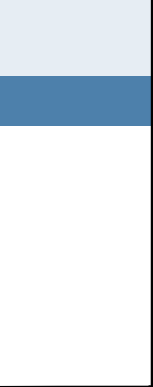

osition
e

on

“ TM m

T † § ~

6 O J U N N

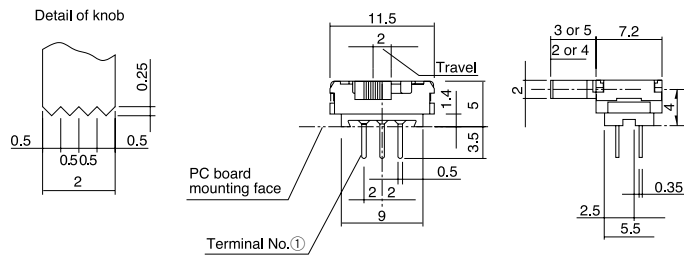
/ P	TM	† — È ^ ð ½ d j m 1 " Z _ A
	<p>2-pole, 2-position Standard type</p> 	
	<p>2-pole, 2-position Snap-in type</p>	
	<p>2-pole, 3-position Standard type</p>	
	<p>2-pole, 3-position Snap-in type</p>	

■ (l † W % 6 O J U N N

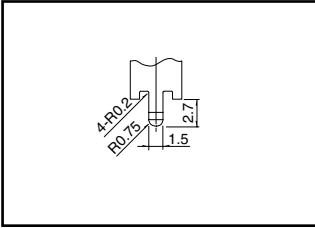

■ È ^ m 1 " Z _ A

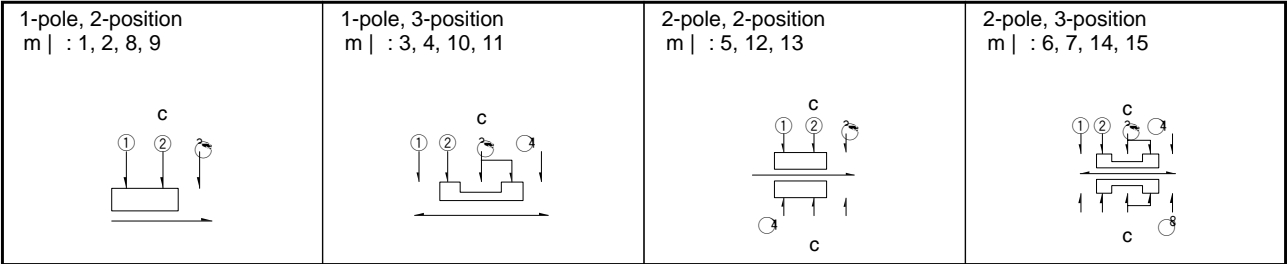



小型通用

大型通用

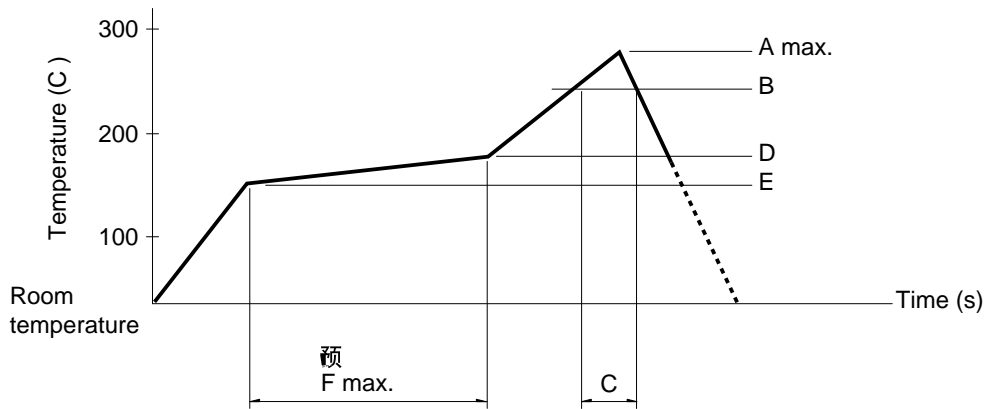

①		②	③	④	⑤	⑥	⑦
SSSS2	Vertical	1-pole, 3-position					
	Horizontal	1-pole, 2-position 1-pole, 3-position 2-pole, 3-position					
	Vertical	1-pole, 2-position					
SSSS7							
SSAH, SSAG, SSAJ, SSAL, SSSS8							

小型通用

大型通用

■ mφ

"	oM	oHW
SSSF, SSSU	AE	T
SSSS2	AE	BY
SSSS9	AE	BY
SSAH, SSAG, SSAJ, SSAL	AE	BY
	AE	BY
SSSS7	AE	BY
SSAC	AE	BY

■ b

aB1CSB

"	[b	
	o	oHW	oM	oHW
SSSS2	BE	BY	AE	T
SSSS9	BE	BY	AE	WRE
SSSF, SSSU	BE	BY	AE	T T
SSAC	BE	BY	AE	T